

ArcReach® Wire Feeders

Voltage-Sensing Wire Feeder 

Quick Specs

Heavy Industrial Applications

Shipbuilding
Construction
Heavy manufacturing
Rental

Processes

MIG (GMAW)
Flux-cored (FCAW)
Pulsed MIG (GMAW-P)*
RMD®**
Air carbon arc (CAC-A) cutting and gouging**
Rated: 3/8-inch carbons

*Available with ArcReach Smart Feeder only.

**Available with ArcReach 16 with XMT® 650 only.

Wire Feed Speed

SuitCase 8 and 12: 50–780 ipm (1.3–19.8 m/min.)
SuitCase 12 Heavy Duty: 30–400 ipm (0.76–10.2 m/min.)
ArcReach 16: 50–780 ipm (1.3–19.8 m/min.)
Smart Feeder: 50–500 ipm (1.3–12.7 m/min.)

Net Weight

SuitCase 8: 28 lb. (13 kg)
SuitCase 12 and 12 Heavy Duty: 35 lb. (15.9 kg)
ArcReach 16 (base feeder): 101 lb. (45.8 kg)
Smart Feeder: 50 lb. (23 kg)



Game-changing welding technologies can stop you from wasting hours every day.

ArcReach welding technology minimizes the non-value-added time spent walking to and from the power source — and maximizes arc-on time, weld quality and jobsite safety.

When operators have complete control at the feeder or remote — even hundreds of feet away from the power source — it minimizes downtime and maximizes productivity, while improving operator safety and delivers high quality welds.



More Jobsite Productivity and Efficiency



Increased Uptime



Improved Jobsite Safety



Maximum Fleet Compatibility



More Operator Control



ArcReach SuitCase® 8

ArcReach SuitCase® 12

ArcReach 16

ArcReach Smart Feeder

ArcReach®

Remote voltage control at the wire feeder or remote without needing a control cord. See page 2 for more information.



Wire feeder is warranted for three years, parts and labor.



Miller Electric Mfg. LLC
An ITW Welding Company
1635 West Spencer Street
P.O. Box 1079
Appleton, WI 54912-1079 USA

Equipment Sales US and Canada
Phone: 866-931-9730
FAX: 800-637-2315
International Phone: 920-735-4554
International FAX: 920-735-4125

MillerWelds.com



ArcReach® Wire Feeders Benefits



More Jobsite Productivity and Efficiency

ArcReach capabilities eliminate the time spent tracing weld cables hundreds of feet back to the power source because weld operators can make adjustments at the ArcReach wire feeder or remote.

- **Cable Length Compensation (CLC™)** ensures that the voltage a weld operator sets is the voltage they get by automatically adjusting voltage based on weld cable length, even hundreds of feet away from the power source. *(Only available when connected to an XMT® 350 FieldPro™ or XMT 650 ArcReach power source).*



Increased Uptime

ArcReach feeders and remotes have been extensively field-proven and deliver the performance you need with ruggedly constructed internal components.

- **No more expenses related to maintaining or replacing easily damaged control cords** because the weld cables are used to communicate weld parameters between the wire feeder and power source.



Improved Jobsite Safety

The chances of slip, trip or fall injuries are decreased because ArcReach technology allows weld operators to make parameter changes at the wire feeder/remote instead of having to travel through multistory and cluttered jobsites back to the power source.



Maximum Fleet Compatibility

Maximize fleet compatibility and get the benefits of ArcReach when you pair XMT 350 FieldPro or XMT 650 ArcReach welders and ArcReach feeders with other ArcReach compatible products.



More Operator Control

More control for weld operators with quick, easy adjustments at the wire feeder/remote.

- **Weld operators can Adjust While Welding (AWW™)** to change weld parameters while the arc is on. *(Only available when connected to an XMT 350 FieldPro or XMT 650 ArcReach power source).*
- **Inadvertent parameter changes by other jobsite workers can be easily avoided** because connecting an ArcReach accessory from the power source automatically locks out the power source's panel controls.
- **Return to a previous weld process faster** because the power source is restored to its previous settings once the ArcReach accessory is removed.
- **Decrease the chance of an incorrect weld process being used** because Auto-Process Select™ automatically sets the power source to the correct weld process based on the polarity applied to the weld accessory.

ArcReach®

Remote control of the power source without a control cord.

ArcReach technology uses the existing weld cable to communicate welding control information between the feeder or remote and power source. This technology eliminates the need for control cords, and their associated problems and costs.

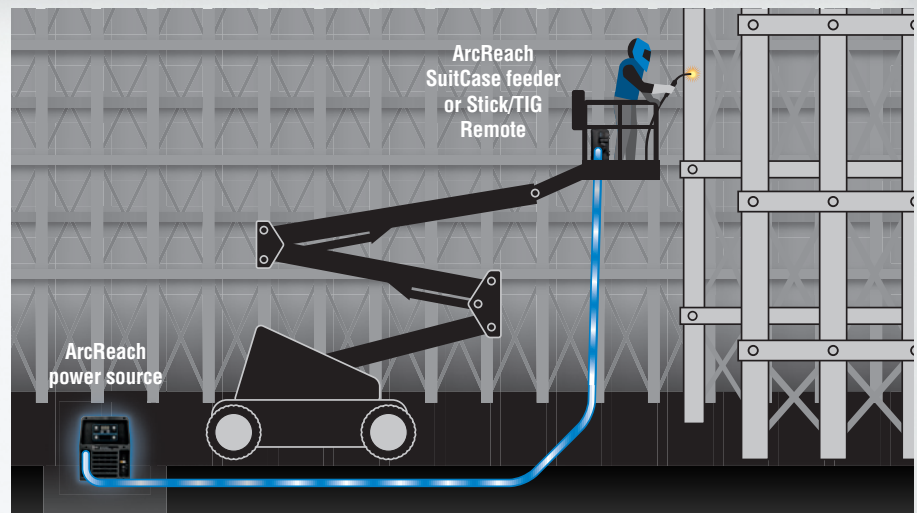

Power Source Compatibility for ArcReach® Wire Feeders

ArcReach SuitCase® 8/12 and ArcReach 16

Power Source	Wire Feed Speed	Remote Voltage Control	Front Panel Lockout	Auto Process Reversion	Adjust While Welding (AWW™)	Cable Length Compensation (CLC™)	Remote/ Auto-Process Select™	Compatibility
XMT® 350 FieldPro™ NPR	■	■	■	■	■	■	■	Best
XMT® 350 FieldPro™ PR	■	■	■	■	■	■	■	Best
XMT® 650 ArcReach®	■	■	■	■	■	■	■	Best
XMT® 650 ArcReach® PR	■	■	■	■	■	■	■	Best
Trailblazer® 330	■	■	■	■		■	■	Better
XMT® 450 CC/CV ArcReach®	■	■	■	■				Better
Bobcat™ 265	■	■	■	■		WLC*	■	Better
Big Blue® Pro Series	■	■	■	■			■	Better
XMT® 350 CC/CV	■							Good
XMT® 350 MPa	■							Good
XMT® 450 CC/CV	■							Good
XMT® 450 MPa	■							Good
XMT® 650 CC/CV	■							Good
Maxstar® 280 Multiprocess	■							Good
Dynasty® 300 Multiprocess	■							Good
Bobcat™ 200 Air Pak™	■							Good

Note: Chart above only contains current power sources. For all ArcReach-capable products contact your product specialist.

*Weld Lead Compensation (WLC) allows operators to manually enter the length of their weld cables so the power source can calculate the voltage drop and compensate so weld voltage settings are closer to what is set on the ArcReach feeder/accessory.

ArcReach Smart Feeder Chart

Power Source	Remote Voltage Control	Front Panel Lockout	Auto Process Reversion	Adjust While Welding (AWW™)	Trigger Select On/Off	Memory Select
XMT® 350 FieldPro™ NPR (Best)	■	■	■	■	■	■
XMT® 350 FieldPro™ PR (Best)	■	■	■	■	■	■
Big Blue® Pro Series (ArcReach®-equipped models only)	■	■	■	■	■	■
Trailblazer® 330 Series (all models)	Not compatible					
Bobcat™ 265 (all models)	Not compatible					

ArcReach® SuitCase® 8 and 12 Features

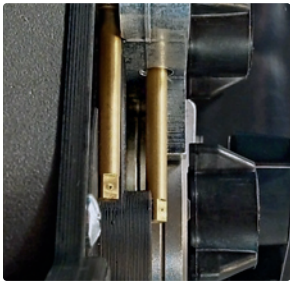

Ultra-low drag inlet guide pins make loading the wire easy and do not deform the wire on the way into the drive rolls. Simply thread the wire through the pins and into drive rolls. There are two ways to advance the wire through the drive roll and into the gun. Either open the pressure arm and thread the wire into the grooves in the drive roll and on into the gun inlet **or** place the wire between the pins and use the jog/purge switch to advance the wire through the drive roll.



Scaled wire pressure knob provides easy adjustment and consistent pressure on the drive rolls and wire. **Wire drive and motor assembly** is specifically designed for mobile welding applications to provide smooth and consistent wire delivery. Improved motor torque and drive roll system are designed to feed small-diameter solid wire (.023 inch) to large-diameter cored wire (5/64 inch). The Suitcase 12 Heavy Duty model has a lower gear ratio which extends the wire diameter range to include 3/32-inch cored wire.

Electronic wire feed speed control with integrated tachometer ensures wire feed speed accuracy and consistency that rivals the best benchtop feeders — making it easier to produce quality welds.

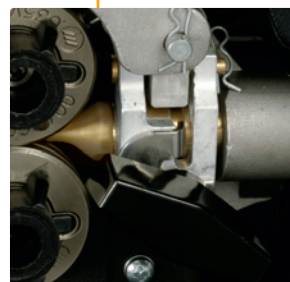

Gun locking tab works with guns having corresponding locking grooves to prevent gun from being pulled out if the feeder is dragged by the gun.



Potted and trayed main printed circuit board for the harshest environments adds exceptional reliability. Board has full-trigger isolation so a shorted gun trigger will not affect feeder operation.

Digital meters with SunVision™ technology can display voltage and wire speed, and also amperage if desired. Meters can be seen clearly even in direct sunlight.

Polypropylene case with built-in slide rails and the ability to open the door to change wire with feeder in vertical position.

Wire speed dual schedule reduces wire speed to 87.5 percent of standard speed. Requires a dual schedule gun or dual schedule switch (sold separately).



Gas inlet recessed into back of case is protected from incidental contact by the weld cable, ensuring consistent and contaminant-free shielding gas delivery to the gun. **Double-filtered gas valve** helps keep dirt from clogging and affecting gas flow.

ArcReach® SuitCase® Features

Setting the standard for performance. Heavy-duty drive motor with tachometer control provides wire feed speed that is accurate and consistent from the start of the weld to the finish and from one weld to the next, which provides consistent arc quality. Wide voltage range for small and large wires with no contactor chatter or arc outages.

Set volts and wire feed speed remotely. The simple interface on the feeder allows operators to adjust parameters at the point of use with no control cords.

Durable design reduces downtime. Impact-resistant case and the elimination of feeder control cords provides a solid solution to last in harsh environments.



Easy process changeover. Simply connect the ArcReach SuitCase feeder to your weld lead and you are ready to go. The power source automatically switches settings to run conventional wire processes.

Easy solution for traditional wire process. Add the flux-cored capability of the XMT 350 FieldPro™ for fill and cap passes for increased productivity.

Weld with large diameter (3/32 in.) wire. The ArcReach SuitCase 12 Heavy Duty model is specifically designed to applications using 3/32-inch wire.

ArcReach® SuitCase® Control Panel

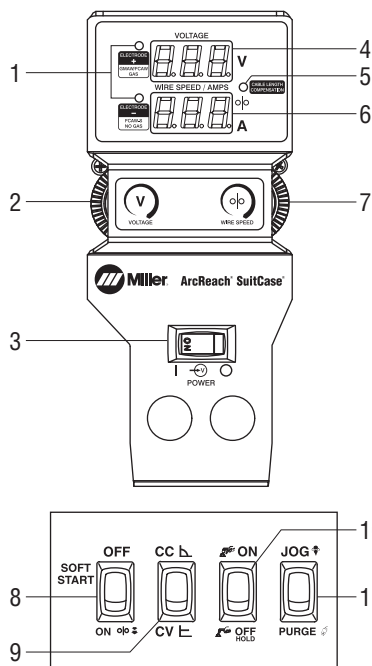

1. Polarity Indicators
2. Voltage Control
3. Power Control Switch
4. Voltmeter
5. Cable Length Compensation (CLC) Indicator
6. Wire Speed/Amperage Meter
7. Wire Speed Control
8. Soft Start Switch
9. CC/CV Switch
10. Trigger Hold Switch
11. Jog/Purge Switch

Internal Control Panel

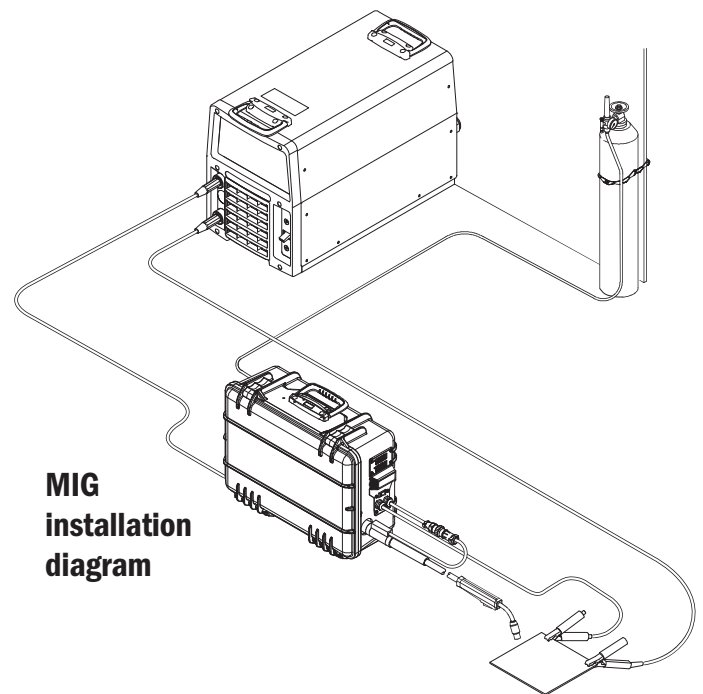

MIG installation diagram

ArcReach® SuitCase® Specifications (Subject to change without notice.)

CC CV DC (Use with CC or CV, DC power sources.)

Model	Input Power	Input Welding Circuit Rating	Wire Feed Speed	Wire Type and Diameter Capacity	Max. Spool Size Capacity	Dimensions	Net Weight
8	Operates on open-circuit voltage and arc voltage: 14–48 VDC/110 max. OCV	330 A at 60% duty cycle	50–780 ipm (1.3–19.8 m/min.) dependent on arc voltage	Solid wire: .023–.052 in. (0.6–1.4 mm) Flux-cored: .030–5/64 in. (0.8–2.0 mm)	8 in. (203 mm) 14 lb. (6.4 kg)	H: 12.75 in. (324 mm) W: 7.25 in. (184 mm) D: 18 in. (457 mm)	28 lb. (13 kg)
12		425 A at 60% duty cycle		Solid wire: .023–.052 in. (0.6–1.4 mm) Flux-cored: .030–5/64 in. (0.8–2.0 mm)			
12 Heavy Duty		450 A at 60% duty cycle	30–400 ipm (0.76–10.2 m/min.) dependent on arc voltage	Flux-cored: .030–3/32 in. (0.8–2.4 mm)			

ArcReach® 16 Features

Set volts, wire feed speed and process remotely.

The simple interface allows operators to adjust parameters at the point of use with no control cords.

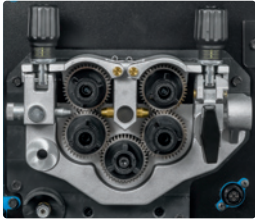

Setting the standard for performance. Heavy-duty drive motor with tachometer control provides wire feed speed that is accurate and consistent from the start of the weld to the finish and from one weld to the next, providing consistent arc quality. Wide voltage range for small and large wires with no contactor chatter or arc outages.



Easy process changeover. Simply connect the ArcReach 16 wire feeder to your weld lead and you are ready to go. Switch between welding and gouging with a push of a button with no need to swap leads or disconnect the wire feeder with isolated outputs.

Weld with up to 60-pound spools and large diameter (3/32 in.) wire to minimize downtime and maximize productivity.

Integrated gouging stud on wire feeder. Isolated gouging stud allows easy connection for gouging at point of use, eliminating the need to disconnect the wire feeder and to swap leads.

Durable design reduces downtime. The elimination of feeder control cords and field assembly IP23 rating provides a solid solution to last in harsh environments.

ArcReach® 16 Options

Easy mobility in the shop and on-site. The ArcReach 16 wire feeder preassembled options include a shop cart and a field roller for your mobility needs.



Bench feeder



Preassembled shop cart provides easy shop mobility with low clearance. Handle doubles as a cable holder.



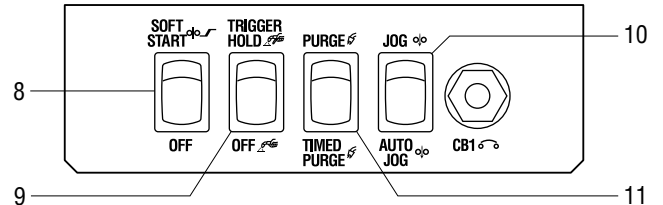
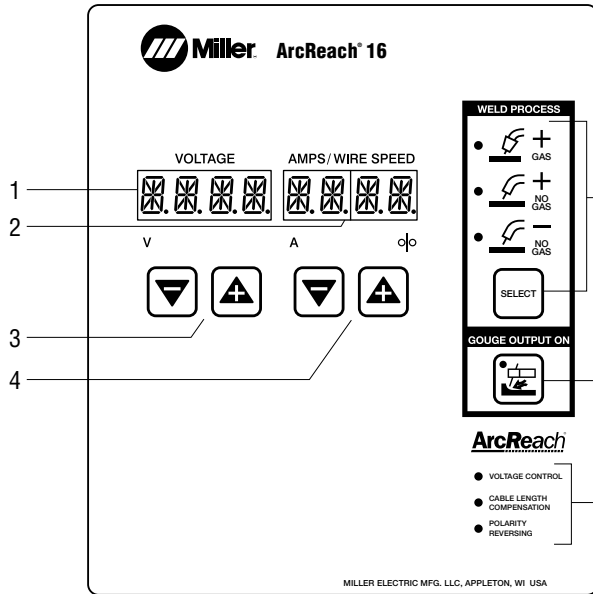

Preassembled field roller provides easy field mobility over pan decking and other surfaces. Designed for the environment with spool cover and IP23 rating. Includes spool cover, hanging bail and cable holder.

ArcReach® 16 Control Panel



1. Voltmeter
2. Amperage / Wire Speed Meter
3. Voltage Control
4. Wire Speed Control
5. Weld Process Selection and Indicators
6. CAC-G Selection
7. ArcReach Feature Indication
8. Soft Start Switch
9. Trigger Hold Switch
10. Purge/Timed Purge
11. Jog/Auto Jog

ArcReach® 16 Specifications (Subject to change without notice.)

  (Use with CC or CV, DC power sources.)

Input Power	Input Welding Circuit Rating	Wire Feed Speed	Wire Type and Diameter Capacity	Max. Spool Size Capacity	Dimensions (H x W x D)	Net Weight
Operates on open-circuit voltage and arc voltage: 12–110 VDC	450 A at 100% duty cycle	50–780 ipm (1.3–19.8 m/min.) dependent on arc voltage	Solid wire .035–5/64 in. (0.9–1.9 mm)	18 in. (457 mm) 60 lb. (27.2 kg)	Base feeder 15.3 x 16.7 x 32.8 in. (388 x 424 x 833 mm)	Base feeder 101 lb. (45.8 kg)
	500 A at 60% duty cycle		Flux-cored .045–3/32 in. (1.1–2.4 mm)		Shop cart 20 x 24.9 x 36.3 in. (508 x 632 x 922 mm)	Shop cart 120 lb. (54.4 kg)
	CAC-A 600 A at 40% duty cycle				Field roller 28.2 x 19.9 x 42.7 in. (716 x 505 x 1,084 mm)	Field roller 123 lb. (55.7 kg)

ArcReach® Smart Feeder Features

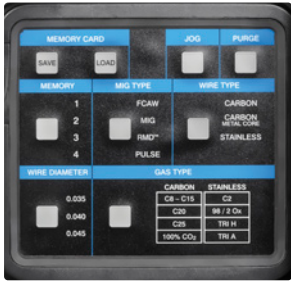

Internal control panel duplicates many front panel selections so the processes can be configured and selected from the front panel while using, or from the inside while loading wire and preparing the Smart Feeder for use.



Scaled wire pressure knob provides easy adjustment and consistent pressure on the drive rolls and wire. **Wire drive and motor assembly** is specifically designed for mobile welding applications to provide smooth and consistent wire delivery. Improved motor torque and drive roll system are designed to feed small-diameter solid wire (.023 inch) to large-diameter cored wire (5/64 inch).

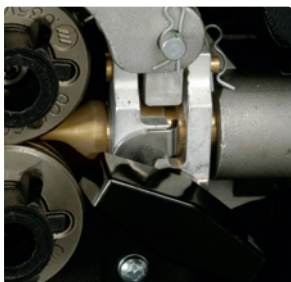

Gun locking tab works with guns having corresponding locking grooves to prevent gun from being pulled out if the feeder is dragged by the gun.

Electronic wire feed speed control with integrated tachometer ensures wire feed speed accuracy and consistency that rivals the best benchtop feeders — making it easier to produce quality welds.



Potted and trayed main printed circuit board for the harshest environments adds exceptional reliability. Board has full-trigger isolation so a shorted gun trigger will not affect feeder operation.

Digital meters with SunVision™ technology can display voltage and wire speed, and also amperage if desired. Meters can be seen clearly even in direct sunlight.

Memory select button and location indicator. Store up to four weld process settings for easy access. Simply press and release the button to recall stored settings. Stores your settings that can be recalled at any time by selecting the appropriate memory location.

Polypropylene case and the ability to open the door to change wire with feeder in vertical position.

Gas inlet recessed into back of case is protected from incidental contact by the weld cable, ensuring consistent and contaminant-free shielding gas delivery to the gun. **Double-filtered gas valve** helps keep dirt from clogging and affecting gas flow.

Wire speed dual schedule reduces or increases wire speed to a programmable value. Requires a dual schedule gun or dual schedule switch (sold separately).

ArcReach® Smart Feeder Features

ArcReach Smart Feeder delivers excellent RMD® and pulsed MIG welding up to 200 feet away from the power source with no control cords — twice the distance previously possible. RMD and pulsed MIG processes also help reduce weld failures and eliminate backing gas on some stainless and chrome-moly applications.

Easy process changeover. Simply connect the ArcReach Smart Feeder to your leads and you are ready to go. All controls automatically shift to the ArcReach Smart Feeder.



Synergic processes. RMD and pulsed MIG welding permits procedures with one wire and one gas to eliminate process switch-over time.

Durable design reduces downtime. Impact-resistant case and the elimination of feeder control cords provide a solid solution to last in harsh environments.

ArcReach® Smart Feeder Control Panel

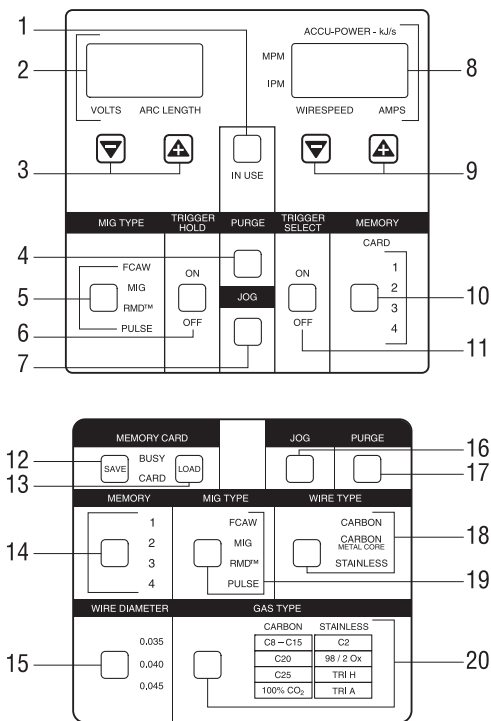

Internal Control Panel

1. In-Use Button and Indicator
2. Arc Length/Volts Display and Indicators
3. Arc Length/Volts Decrease and Increase Buttons
4. Purge Button
5. MIG Type Select Button and Indicator
6. Trigger Hold On/Off Button
7. Jog Button
8. Amps/Wire Feed Speed Display and Indicators
9. Amps/Wire Feed Speed Decrease and Increase Buttons
10. Memory Select Button and Location Indicator
11. Trigger Select On/Off Button
12. Memory Card Button
13. Memory Card Load Button
14. Memory Select Button and Location Indicator
15. Wire Diameter Select Button and Indicator
16. Jog Button
17. Purge Button
18. Wire Type Select Button and Indicator
19. MIG Type Select Button and Indicator
20. Gas Type Select Button and Indicator

ArcReach® Smart Feeder Specifications (Subject to change without notice.)



(Use with ArcReach-equipped power sources.)

Input Power*	Input Welding Circuit Rating	Wire Feed Speed	Wire Diameter Capacity	Max. Spool Size Capacity	Dimensions	Net Weight
XMT® 350 FieldPro™ connected to three-phase power or a compatible ArcReach-equipped engine drive	275 A at 60% duty cycle	50–500 ipm (1.3–12.7 m/min.) dependent on arc voltage	.035–.045 in. (0.9–1.1 mm)	12 in. (305 mm), 33 lb. (15 kg)	H: 18 in. (457 mm) W: 13 in. (330 mm) D: 21.5 in. (546 mm)	50 lb. (23 kg)

*XMT 350 FieldPro must be connected to three-phase power when using the ArcReach Smart Feeder. Using single-phase may cause the feeder to unpredictably interrupt welding.

ArcReach® Smart Feeder Welding Process Capabilities

The ArcReach® Smart feeder connected to an ArcReach-equipped power supply or engine drive provides standard welding process programs specifically designed for the welding of carbon steel and stainless steel pipe. The RMD® (MIG-modified short circuit) programs and pulsed MIG programs are synergic programs designed specifically for combinations of wire type, wire diameter and shielding gas.

Carbon Steel Programs		Wire Type			
		Solid Wire			Metal-cored Wire
		.035 in. (0.9 mm)	.040 in. (1.0 mm)	.045 in. (1.1/1.2 mm)	.045 in. (1.1/1.2 mm)
Shielding Gas	100% CO ₂	MIG, RMD	MIG, RMD	MIG, RMD	
	C25 (argon/25% CO ₂)	MIG, RMD	MIG, RMD	MIG, RMD	RMD
	C20 (argon/20% CO ₂)	MIG, RMD, Pulse	MIG, RMD, Pulse	MIG, RMD, Pulse	RMD
	C8-15 (argon/8–15% CO ₂)	MIG, RMD, Pulse	MIG, RMD, Pulse	MIG, RMD, Pulse	Pulse

Stainless Steel Programs		Wire Type		
		Solid Wire		
		.035 in. (0.9 mm)	.040 in. (1.0 mm)	.045 in. (1.1/1.2 mm)
Shielding Gas	C2 (argon/2% CO ₂)	MIG, RMD, Pulse	MIG, RMD, Pulse	MIG, RMD, Pulse
	98/2 (argon/2% oxygen)	MIG, RMD, Pulse	MIG, RMD, Pulse	MIG, RMD, Pulse
	Tri H (90% He/7.5% Ar/2.5% CO ₂)	MIG, RMD, Pulse		MIG, RMD, Pulse
	Tri A (81% Ar/18% He/1% CO ₂)	MIG, RMD, Pulse		MIG, RMD, Pulse

RMD® (Regulated Metal Deposition)

A precisely controlled short-circuit metal transfer that provides a calm, stable arc and weld puddle. This provides less chance of cold lap or lack of fusion, less spatter and a higher quality root pass on pipe. The stability of the weld process lessens the puddle manipulation required by the welder and is more tolerant to hi-lo conditions, reducing training requirements. Weld bead profiles are thicker than conventional root pass welds which can eliminate the need for a hot pass, improving weld productivity. In some stainless steel applications, it may be possible to eliminate the backing (purge) gas to further improve productivity and reduce welding costs.



RMD® carbon steel

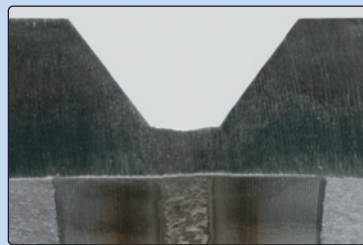

RMD® stainless

Pulsed MIG

This method of pulse welding provides a shorter arc length, narrower arc cone and less heat input than with traditional spray pulse transfer. Since the process is closed-loop, arc wandering and variations in tip-to-work distances are virtually eliminated. This provides easier puddle control for both in-position and out-of-position welding, reducing welder training time. The process also improves fusion and fill at the toe of the weld, permitting higher travel speeds and higher deposition. This process coupled with RMD for root pass welding permits welding procedures with one wire and one gas to eliminate process switch-over time.



Pulsed MIG carbon



Pulsed MIG stainless

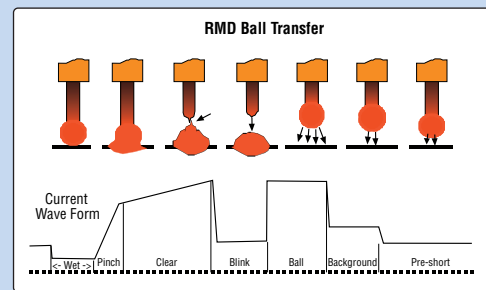

- Ideally suited to root pass welding
- Consistent side wall fusion
- Less weld spatter
- Tolerant to hi-lo fit-up conditions
- More tolerant of tip-to-work distance
- Less welder training time
- Thicker root passes can eliminate hot pass
- Eliminate backing gas on some stainless steel applications

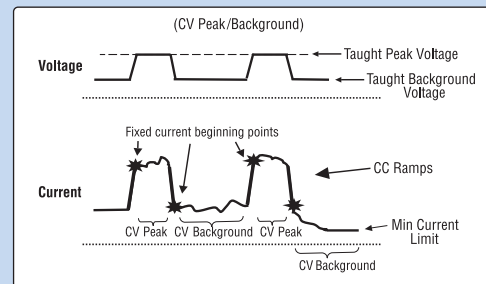





- Ideally suited to fill and cap pass welding
- Easier puddle control than conventional spray pulse
- Shorter arc lengths and narrow arc cone for out-of-position welding
- More tolerant of tip-to-work variation
- Improve fusion and fill at toe of weld
- Less heat input reduces interpass cooling time and improves weld cycle time
- Enables one-wire with one-gas weld procedures

Drive Rolls, Kits and Guides

ArcReach® SuitCase® and Smart Feeder

Select drive rolls (two required) or kits (one required) from chart below according to type and wire size being used. Wire inlet guide comes installed on this wire feeder.

Wire Size	"V" groove for hard wire 	"U" groove for soft wire or soft-shelled cored wires 	"V" knurled for hard-shelled cored wires 	"U" coggled for extremely soft wire or soft-shelled cored wires (i.e., hard facing types) 
.023/.025 in. (0.6 mm)	087130	—	—	—
.030 in. (0.8 mm)	053695	—	—	—
.035 in. (0.9 mm)	053700	072000	132958	—
.040 in. (1.0 mm)	053696	—	—	—
.045 in. (1.1/1.2 mm)	053697	053701	132957 (roll) / 301091* (kit)	083489
.052 in. (1.3/1.4 mm)	053698	053702	132956	083490
1/16 in. (1.6 mm)	053699	053706	132955 (roll) / 301091* (kit)	053708
.068/.072 in. (1.8 mm)	—	—	132959 (roll) / 301092** (kit)	—
5/64 in. (2.0 mm)	—	053704	132960 (roll) / 301092** (kit)	053710
3/32 in. (2.4 mm)	—	053703	132961 (roll) / 294491 (kit)	053709

*Dual-size reversible drive rolls with one .045-inch and one 1/16-inch groove. **Dual-size reversible drive rolls with one .068/.072-inch and one 5/64-inch groove.

ArcReach® 16

Select drive roll kits from chart below according to type and wire size being used. Kits include four drive rolls, necessary guides and feature an anti-wear sleeve for inlet guide.

Wire Size	V-groove for hard wire	V-knurled for hard-shelled cored wires	U-coggled for extremely soft wire or soft-shelled cored wires (i.e., hard facing types)
.035 in. (0.9 mm)	151026	151052	—
.035 and .045 in. (0.9 and 1.2 mm)	235336*	—	—
.040 in. (1.0 mm)	161190	—	—
.045 in. (1.1/1.2 mm)	151027	151053	151070
.052 in. (1.3/1.4 mm)	151028	151054	—
1/16 in. (1.6 mm)	151029	151055	151072
.068/.072 in. (1.8 mm)	—	151056	—
5/64 in. (2.0 mm)	—	151057	—
3/32 in. (2.4 mm)	—	294490	—

*Dual-size reversible drive rolls with one .035-inch and one .045-inch groove.

Wire Guides

Wire Size	Inlet Guide	Intermediate Guide
.023–.040 in. (0.6–1.0 mm)	221030	056206
.045–.052 in. (1.2–1.3 mm)	221030	056207
1/16–5/64 in. (1.6–2.0 mm)	221030	056209
5/64–1/8 in. (2.0–3.2 mm)	229919	056211

Bernard® Guns

IronPro™ Self-Shielded FCAW Gun



Designed for structural steel erector sites. Includes 15-foot (4.6 m) cable and short handle for excellent joint access and maneuverability.

- Rated at 450 amps at 60 percent duty cycle
- Includes AccuLock™ consumables with 3/32 in. (2.4 mm) liner for large diameter FCAW wires
- Extended life with sealed trigger that remains slag and spatter free, gasless tip insulation and replaceable neck
- Ergonomic design provides excellent access and maneuverability for hard-to-reach weld joints
- Durable gun ideal for outdoor environments

PipeWorx 300-15 Air-Cooled MIG Gun



Recommended for root pass welding, especially in fixed-position applications where visibility is difficult. Comes with 15-foot (4.6 m) cable, tapered tip and nozzle. NEMA rated at 350 amps at 100 percent duty cycle with CO₂ gas. Switch to a standard tip and nozzle for fill and cap pass welding with flux-cored or pulsed MIG welding processes. This allows one gas and one wire to make the weld.

Insulators	NS-AFLX NS-AFLX-HD	Gasless tip insulation Armored tip insulation
"Q" Neck Assemblies (AccuLock)	1370270 1370271	Gasless, 12 in. long, 45° bend Gasless, 7 in. long, 60° bend
Liners	L7A-15 LD8A-15	3/32 in. (2.4 mm) 3/32 in. (2.4 mm) D wound
Jump Liners	QJL-L7 QJL-LD8	Gasless, 3/32 in. (2.4 mm) Gasless, 3/32 in. (2.4 mm) D wound
Tips	T-A078CH T-A094CH	5/64 in. (2.0 mm) 3/32 in. (2.4 mm)
Heat Shield	1760013	"Q" neck adapter, one-piece

Head Tube	QT2-60	60° bend, "Q" tube assembly
Liner	415-35-152	.035–.045 in. (0.9–1.2 mm)
Tip	T-045	.045 in. (0.9 mm)
Nozzle	NS-5818C	5/8 in. ID
Diffuser	DS-1	



Ordering Information

Equipment and Options	Stock No.	Description	Qty.	Price
ArcReach® SuitCase® 8 MIG/FCAW Feeder with Tweco-style Connectors	951726001	With drive rolls and Bernard BTB Gun 300 A with AccuLock™ consumables		
	951727	With drive rolls and Bernard S-Gun™ with Quik Tip™ consumables		
	951728	With drive rolls and Bernard Dura-Flux™ gun with Centerfire™ consumables		
	301457	Feeder only		
ArcReach® SuitCase® 12 MIG/FCAW Feeder with Tweco-style Connectors	951729001	With drive rolls and Bernard BTB Gun 300 A with AccuLock™ consumables		
	951730	With drive rolls and Bernard S-Gun™ with Quik Tip™ consumables		
	951731	With drive rolls and Bernard Dura-Flux™ gun with Centerfire™ consumables		
	951732	With drive rolls and Bernard PipeWorx 300-15 MIG gun with Centerfire™ consumables		
301456	Feeder only			
ArcReach® SuitCase® 12 Heavy Duty FCAW Feeder w/Tweco-style connectors	301604	Feeder only. For 3/32 in. flux-cored wire		
	951000096	With Bernard® IronPro™ flux-cored gun with AccuLock™ consumables		
ArcReach® 16 MIG/FCAW/CAC-A Feeder	301619	Base feeder only		
	301664	With shop cart		
	951000065	With shop cart and Bernard® BTB Gun 500 A with AccuLock™ consumables		
	301663	With field roller		
951000066	With field roller and Bernard® IronPro™ flux-cored gun with AccuLock™ consumables			
ArcReach® Smart Feeder MIG/FCAW/RMD®/Pulse Feeder	951733	With Tweco-style connectors, drive rolls and Bernard PipeWorx 300-15 MIG gun with Centerfire™ consumables		
	300935	Feeder only with Tweco-style connectors		
	300935001	Feeder only with Dinse-style connectors		
Flowmeter Kit	301306	For SuitCase and Smart feeders only		
Spool Adapter	047141	For 14 lb. spools. For SuitCase and Smart feeders only		
Wire Reel Assembly	108008	For 60 lb. coils. For ArcReach 16 only		
International Gun Adapter	164902	Adapter is required to connect ArcReach SuitCase to a Euro-style gun		
Guns				
Bernard® BTB Gun 300 A (GMAW)		See Bernard literature SP-BTB		
Bernard® BTB Gun 500 A (GMAW)		See Bernard literature SP-BTB		
Bernard® S-Gun™ (GMAW)	S2515TE5EM	See Bernard literature SP-S25		
Bernard® Dura-Flux™ (FCAW)		See Bernard literature SP-DF		
Bernard® IronPro™ (FCAW)	GL4515MLNM	15 ft. (4.6 m), AccuLock™ consumables, 5/64 and 3/32 in. tips, 12 in. 45° neck		
Bernard® PipeWorx 300-15 (GMAW)	195400	15 ft. (4.6 m), 300 A air-cooled MIG gun designed for use with all ArcReach smart systems		
Power Sources				
XMT® 350 FieldPro™ Systems		See literature DC/18.96		
XMT® 650 Series		See literature DC/18.98		
XMT® 450 CC/CV with ArcReach		See literature DC/18.94		
Big Blue® 400 Pro and 400 PipePro®		See literature ED/5.7 and ED/5.8		
Big Blue® 500 Pro		See literature ED/11.0		
Big Blue® 600 Series		See literature ED/11.5		
Big Blue® 800 Series		See literature ED/14.0		
Trailblazer® Series		See literature ED/4.76, ED/4.79 and ED/4.86		
Consumables				
Drive Rolls		See page 11		
Wire				

Date:

Total Quoted Price:

Distributed by:

