

# Multimatic® 200

## MIG/Multiprocess Power Source, Wire Feeder and Gun Package



### Quick Specs

#### Light Industrial Applications

Light fabrication  
Maintenance and repair  
Mechanical contractor  
Construction

#### Processes

MIG (GMAW)  
Flux-cored (FCAW)  
DC TIG (GTAW)  
DC stick (SMAW)

#### Weld Thickness

**MIG:** 24 ga.–3/8 in. steel, 18 ga.–3/8 in. aluminum  
**TIG:** .020–3/16 in. steel  
**Stick:** 16 ga.–3/8 in. steel

**Input Power** 120 or 230 V, single-phase, 50/60 Hz

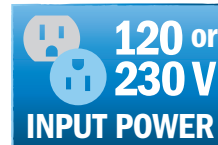

Uses 120- or 230-volt power



Portable

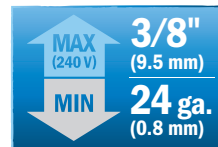

MIG weld capacity



Quick and easy setup

### IMPROVED! AccuLock™

Now with **NEW! MDX™-250 MIG gun with AccuLock™ MDX consumable system** featuring a dual-locked, front-loading liner that optimizes wire feedability.

#### Comes complete with:

- Power source
- 10 ft. (3 m) MDX™-250 MIG gun
- 13 ft. (4 m) cable with electrode holder and 25 mm Dinse-style connector
- 10 ft. (3 m) work cable with clamp and 25 mm Dinse-style connector
- Power cord with MVP™ plugs for 120 and 230 V
- Flow gauge regulator and gas hose for argon or AR/CO<sub>2</sub> mix
- Two contact tips for .030 in. (0.8 mm) wire, and two contact tips for .035 in. (0.9 mm) wire
- Quick Select™ drive roll for .024 in. (0.6 mm) or .030/.035 in. (0.8/0.9 mm) solid wire, and .030/.035 in. (0.8/0.9 mm) flux-cored wire
- Information/settings chart and quick setup guide
- Material thickness gauge ▶ 229895

*Note: Shielding gas and safety equipment not included.*

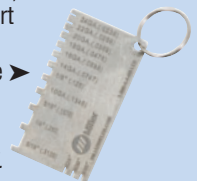

**Lightweight MIG, stick and TIG welder** weighs only 29 pounds (13.2 kg) so it can go anywhere you need to weld.

**Auto-Set™ Elite** can be used on multiple materials and multiple processes with the ability to fine-tune your settings. Easy to set up and use.

**Impact-resistant case** provides strength and durability, protecting the internal components and welding wire.

**Excellent arc characteristics!** Multimatic 200 offers positive arc starts and an extremely stable arc with minimal spatter on both mixed gases and straight CO<sub>2</sub>.

**Multi-voltage plug (MVP™)** allows connection to common 120- and 230-volt power receptacles without the use of any tools—choose the plug that fits the receptacle and connect it to the power cord.



**Optional spool guns.** Spoolmate™ 100 or 150 offer reliable and economical solutions for welding aluminum.

**Optional TIG contractor kit** gives you everything you need for remote TIG welding with the Multimatic 200.



Welder is warranted for three years, parts and labor.  
Gun warranted for 90 days, parts only.



**Miller Electric Mfg. LLC**  
An ITW Welding Company  
1635 West Spencer Street  
P.O. Box 1079  
Appleton, WI 54912-1079 USA

**Equipment Sales US and Canada**  
Phone: 866-931-9730  
FAX: 800-637-2315  
International Phone: 920-735-4554  
International FAX: 920-735-4125

**MillerWelds.com**  
f t y i n



# Specifications (Subject to change without notice.)



Welding Mode/ Process	Input Power	Welding Amperage Range	Rated Output	Amps Input at Rated Output, 50/60 Hz				Wire Feed Speed	Max. Open-Circuit Voltage	Dimensions	Net Weight
				120 V	230 V	KVA	KW				
CV: MIG/ flux-cored	120 V	30–140 A	90 A at 18.5 V, 60% duty cycle	18	—	2.2	2	70–425 ipm (1.8–10.8 m/min.)	90 VDC	H: 14.5 in. (368 mm) W: 9.75 in. (248 mm) D: 17 in. (432 mm)	29 lb. (13.2 kg)
			110 A at 19.5 V, 20% duty cycle	22.4	—	2.7	2.6				
	230 V	30–200 A	150 A at 21.5 V, 20% duty cycle	—	17.5	4.0	3.8		90 VDC (22–25 VDC*)		
CC: TIG	120 V	5–150 A	100 A at 14 V, 100% duty cycle	15.8	—	1.9	1.8	—			
			150 A at 16 V, 30% duty cycle	27	—	3.3	3.2				
	230 V	5–150 A	100 A at 14 V, 100% duty cycle	—	8	1.9	1.7				
			150 A at 16 V, 30% duty cycle	—	13.8	3.2	3.0				
CC: Stick	120 V	20–100 A	70 A at 22.8 V, 100% duty cycle	16.5	—	2.0	1.9				
			100 A at 24 V, 35% duty cycle	24	—	2.9	2.8				
	230 V	20–150 A	100 A at 24 V, 100% duty cycle	—	12.7	2.9	2.7				
			150 A at 26 V, 30% duty cycle	—	20.8	4.8	4.5				

\*Sense voltage for stick and Lift-Arc™ TIG.

Certified by Canadian Standards Association to both the Canadian and U.S. Standards.

## Control Panel

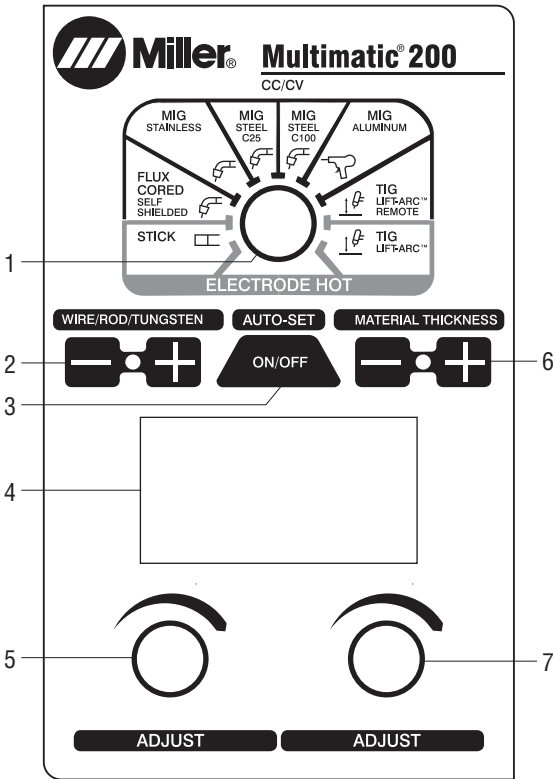

1. Process Selection Knob
2. Wire/Tungsten Diameter and Stick Rod Type Buttons
3. Auto-Set Button
4. LCD Display Panel
5. Adjustment Knob
6. Material Thickness Buttons
7. Adjustment Knob

## Performance Data

MIG Duty Cycle Chart

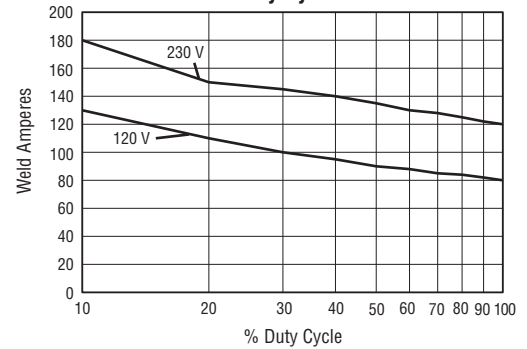

TIG Duty Cycle Chart

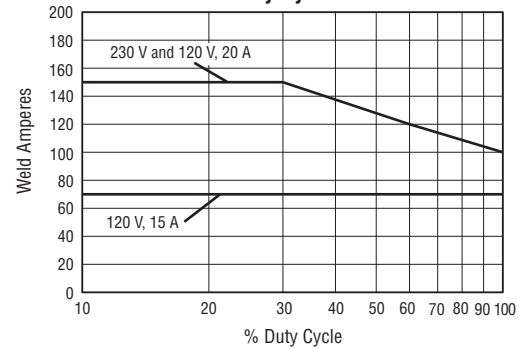

Stick Duty Cycle Chart

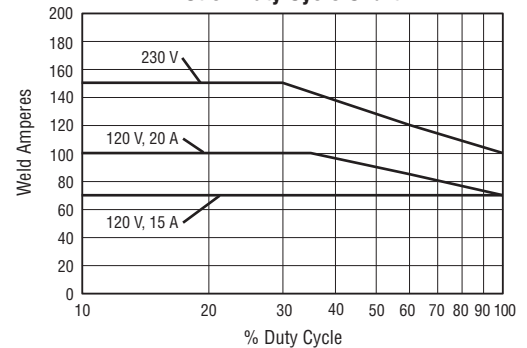

## Genuine Miller® Accessories



### MDX™-250 MIG Gun with AccuLock™ MDX Consumables

**1770035** 10 ft. (3 m), standard

**1770036** 12 ft. (3.7 m)

**1770037** 15 ft. (4.6 m)

Industrial 250-amp MIG gun with consumables for .030/.035 in. (0.8/0.9 mm) wire.

### MDX™-250 MIG Gun with Industrial AccuLock™ S Consumables

**1770041** 10 ft. (3 m)

**1770042** 12 ft. (3.7 m)

**1770043** 15 ft. (4.6 m)

Industrial 250-amp MIG gun with consumables for .035/.045 in. (0.9/1.2 mm) wire.



### Spoolmate™ 100 Spool Gun 300371

Direct-connect spool gun handles .030–.035 inch (0.8–0.9 mm) aluminum (4043 only) and .023–.035 inch

(0.6–0.9 mm) steel/stainless steel wires. Rated at 135 amps, 30 percent duty cycle. Includes 12-foot (3.7 m) cable assembly and custom carrying case.



### Spoolmate™ 150 Spool Gun 301272

Direct-connect spool gun handles .030–.035 inch (0.8–0.9 mm) 4000/5000 series

aluminum and .023–.035 inch (0.6–0.9 mm) steel/stainless steel wires. Rated at 150 amps, 60 percent duty cycle. Includes 20-foot (6.1 m) cable assembly.



### TIG Contractor Kit 301287

Kits comes complete with everything needed to TIG weld with the Multimatic 200. Includes Weldcraft™ A-150 TIG torch with Dinse-style connector, RFCS-6M foot control, flow gauge regulator with 12-foot (3.7 m) gas hose, and AK2C torch accessory kit.



### RCCS-6M Remote Contactor and Current Control 195184

North/south rotary-motion fingertip control attaches to TIG torch using two hook-and-loop fasteners. Includes 13.25-foot (4 m) cord and 6-pin plug.



### 14-Pin to 6-Pin Adapter Cord 300507

Adapts Miller 14-pin foot control or fingertip control to a 6-pin plug.



### Dual Cylinder Rack Cart 951770

Package consists of both running gear/cylinder rack 301239 and dual cylinder rack conversion kit 301454. Cart features durable construction with rubber rear wheels, convenient front handles, cable holders, plastic consumable box, and dual cylinder rack with tool holder. Holds two cylinders, each gas cylinder should be no greater than 7 inches (178 mm) in diameter or 65 pounds (29.5 kg) in weight.

### MVP™ Plugs



#### 219258

For power cable 6-50P (230 V/50 A). Included with machine.



#### 219261

For power cable 5-15P (115 V/15 A). Included with machine.



#### 219259

For power cable 5-20P (115 V/20 A). Optional, not included with machine.

## Consumables

### For MDX™-250 MIG Guns

#### Standard Miller® AccuLock™ MDX Consumables

Smaller consumables and components to access hard-to-reach weldments.

#### Contact Tips (10 per package)

**T-M023** .023 in. (0.6 mm)

**T-M030** .030 in. (0.8 mm)

**T-M035** .035 in. (0.9 mm)

**T-M045** .045 in. (1.2 mm)

**T-M047** 3/64 in. (1.2 mm)

#### Nozzles

**N-M1200C** Copper, 1/2 in. ID, flush, standard

**N-M1218C** Copper, 1/2 in. ID, 1/8 in. recess

**N-M5800C** Copper, 5/8 in. ID, flush

**N-M5818C** Copper, 5/8 in. ID, 1/8 in. recess

**N-M58XTC** Copper, 5/8 in. ID, 1/8 in. stickout

**Diffuser D-M250**

### Monocoil Replacement Liners

#### 10 ft. Liner

**LM1A-10** .023/.025 in. (0.6 mm)

**LM2A-10** .030/.035 in. (0.8/0.9 mm)

**LM3A-10** .035/.045 in. (0.9/1.2 mm)

#### 12 ft. Liner

**LM1A-12** .023/.025 in. (0.6 mm)

**LM2A-12** .030/.035 in. (0.8/0.9 mm)

**LM3A-12** .035/.045 in. (0.9/1.2 mm)

#### 15 ft. Liner

**LM1A-15** .023/.025 in. (0.6 mm)

**LM2A-15** .030/.035 in. (0.8/0.9 mm)

**LM3A-15** .035/.045 in. (0.9/1.2 mm)

### Optional Bernard® AccuLock™ S Consumables

Consumables for increased durability and longer life when guns are used in industrial applications.

#### Contact Tips (10 per package)

**T-A023CH** .023 in. (0.6 mm)

**T-A030CH** .030 in. (0.8 mm)

**T-A035CH** .035 in. (0.9 mm)

**T-A039CH** .039 in. (1.0 mm)

**T-A045CH** .045 in. (1.2 mm)

#### Nozzles

**N-A5800C** Copper, 5/8 in. ID, flush, standard

**N-A5818C** Copper, 5/8 in. ID, 1/8 in. recess

**N-A5814C** Copper, 5/8 in. ID, 1/4 in. recess

**Diffuser D-MA250**

*Note: Miller® FasTip™, M-Series and Bernard Centerfire™ diffusers and consumables are NOT compatible with MDX Series guns.*

## Consumables (Continued)

### For Multimatic® 200



**Quick Select™  
Drive Roll  
261157**

For .024-inch (0.6 mm) or .030/.035-inch (0.8/0.9 mm) solid wire, and .030/.035-inch (0.8/0.9 mm) flux-cored wire.

**V-Knurled Dual-Groove Drive Roll  
202926**

For .030/.035-inch (0.8/0.9 mm) or .045-inch (1.2 mm) flux-cored wire.

### For Spoolmate™ 100



**Contact Tips (5 per package)**

**199730** .024 in. (0.6 mm)  
**186419** .030 in. (0.8 mm)  
**186406** .035 in. (0.9 mm)



**Nozzle  
186405**

### For Spoolmate™ 150



**Contact Tips (5 per package)**

**199387** .030 in. (0.8 mm)  
**199388** .035 in. (0.9 mm)



**Nozzle  
050622**

### For Both Spool Guns



**Drive Roll (1)  
186413**

For .030/.035-inch (0.8/0.9 mm) wire.



**Push Roll (1)  
186414**

For .030/.035-inch (0.8/0.9 mm) wire.

## Ordering Information

Power Source and Options	Stock No.	Description	Qty.	Price
<b>Multimatic® 200</b>	<b>907518</b>	120/230 V, 50/60 Hz		
<b>Multimatic® 200 with TIG Contractor Kit</b>	<b>951649</b>	Power source packaged with 301287 TIG contractor kit		
<b>Guns</b>				
MDX™-250 MIG Gun with AccuLock™ MDX Consumables	<b>1770035</b> <b>1770036</b> <b>1770037</b>	10 ft. (3 m), 250 A, .030/.035 in. (0.8/0.9 mm) wire, standard 12 ft. (3.7 m), 250 A, .030/.035 in. (0.8/0.9 mm) wire 15 ft. (4.6 m), 250 A, .030/.035 in. (0.8/0.9 mm) wire		
MDX™-250 MIG Gun with Industrial AccuLock™ S Consumables	<b>1770041</b> <b>1770042</b> <b>1770043</b>	10 ft. (3 m), 250 A, .035/.045 in. (0.9/1.2 mm) wire 12 ft. (3.7 m), 250 A, .035/.045 in. (0.9/1.2 mm) wire 15 ft. (4.6 m), 250 A, .035/.045 in. (0.9/1.2 mm) wire		
Spoolmate™ 100 Spool Gun	<b>300371</b>	12 ft. (3.7 m). Includes custom carrying case		
Spoolmate™ 150 Spool Gun	<b>301272</b>	20 ft. (6.1 m)		
<b>Accessories</b>				
TIG Contractor Kit	<b>301287</b>	See page 3 for contents		
RCCS-6M Remote Control	<b>195184</b>	North/south fingertip control with 13.25 ft. (4 m) cord and 6-pin plug		
14-Pin to 6-Pin Adapter Cord	<b>300507</b>	Adapts Miller® 14-pin foot control or fingertip control to a 6-pin plug		
Running Gear/Cylinder Rack	<b>301239</b>			
Dual Cylinder Rack Conversion Kit and Tool Holder	<b>301454</b>			
Dual Cylinder Rack Cart	<b>951770</b>	Includes running gear/cylinder rack 301239 and dual cylinder rack conversion kit 301454. Must be assembled together		
MVP™ Plugs		See page 3		
Material Thickness Gauge	<b>229895</b>			
Replacement Screen Cover	<b>231410</b>	Snap-in replacement cover for LCD screen		
Flow Gauge Regulator for Argon or AR/CO <sub>2</sub> Mix	<b>270994</b>	Replacement standard regulator		
Flux-cored Wire				
Solid Wire				
<b>Consumables</b>				
Contact Tips		See page 3 and above		
Nozzles		See page 3 and above		
Diffusers		See page 3		
Monocoil Replacement Liners		See page 3		
Drive Rolls		See above		

Date:

Total Quoted Price:

Distributed by:

