

# Syncrowave® 400

TIG/Stick Welding Power Source 

## Quick Specs



### Industrial Applications

Precision metal fabrication  
Maintenance and repair  
Light and heavy manufacturing  
Shipbuilding  
Tube and pipe  
Automotive  
Vocational

### Processes

TIG (GTAW)  
Stick (SMAW)  
DC pulsed TIG (GTAW-P)

### Input Power

208/240/480 V,  
3-phase or 1-phase power

**Amperage Range** 5–400 A

**Max. Open-Circuit Voltage** 70 VDC

**Rated Output** 400 A at 26 V, 30% duty cycle  
300 A at 22 V, 60% duty cycle

### Net Weight

**Machine only:** 131 lb. (59.4 kg)  
**With Cooler and Running Gear:** 211 lb. (95.7 kg)

**Auto-Link®** circuit automatically links the power source to primary voltage being applied (208/240/480 V, three- or single-phase).

**Simple to install.** Accepts either single- or three-phase input power.

**Small footprint and lightweight design** make it easy to install and maneuver.

**Easy to use.** Intuitive user interface is simple to understand making it easy to adjust parameters, and means less time training new employees and more time getting work done.

**Pro-Set™** eliminates the guesswork when setting weld parameters.

**Energy efficient.** Save up to 33 percent on energy costs versus outdated welding equipment.

**Line voltage compensation** keeps power source constant regardless of fluctuations in input power ( $\pm 10$  percent).

**Arc timer/cycle counter** records actual welding time and number of arc starts. Great for estimating job costs.

**Wind Tunnel Technology™** protects internal electrical components from airborne contaminants, extending the product life.

**Fan-On-Demand™** power source cooling system operates only when needed, reducing noise, energy use and the amount of contaminants pulled through the machine.

**Blue Lightning™** provides more consistent high-frequency (HF) arc starts and greater reliability compared to traditional arc starters.

**Lift-Arc™** provides AC or DC arc initiation without the use of high frequency.



Machine only

Complete package

**More stable arc and better arc starts** versus outdated welding equipment.

**AC squarewave** welding current automatically removes the layer of oxide that forms when welding on aluminum, helping to produce high-quality welds.

**Auto-postflow** adjusts the length of postflow time based on the amperage setting, shielding your tungsten and eliminating the need to set the postflow time.

**Easy-load cylinder rack** minimizes cylinder lifting. Cylinder is not included.

**Internal cooler power supply** runs the Coolmate™ 3S off of the input power and requires no additional hook up.

**Coolmate™ 3S cooler** (Complete packages only). Three-gallon cooling system features a flow indicator to visually indicate system is working and an external filter to stop objects from entering the water-cooled torch cable for better flow and longer life. Extended cooling capacity ensures maximum productivity. One-year cooler warranty.



Power source is warranted for three years, parts and labor.



**Miller Electric Mfg. LLC**  
An ITW Welding Company  
1635 West Spencer Street  
P.O. Box 1079  
Appleton, WI 54912-1079 USA

**Equipment Sales US and Canada**  
Phone: 866-931-9730  
FAX: 800-637-2315  
International Phone: 920-735-4554  
International FAX: 920-735-4125

**MillerWelds.com**



# Weld Process Features

## AC TIG

**Balance** control provides adjustable oxide removal which is essential for creating the highest quality aluminum welds.

**Frequency** controls the width of the arc cone and can improve directional control of the arc.

## DC TIG

**Exceptionally smooth** and precise arc for welding exotic materials.

**Pulse.** Pulsing can increase puddle agitation, arc stability and travel speeds while reducing heat input and distortion.

## DC Stick

**DIG** control allows the arc characteristics to be changed for specific applications and electrodes. Lower the DIG setting for smooth running electrodes like E7018 and increase the DIG setting for stiffer, more penetrating electrodes like E6010.

**Hot Start™** adaptive control provides positive arc starts without sticking.

# AC Output: Balance and Frequency Control

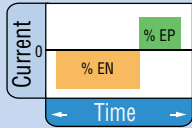
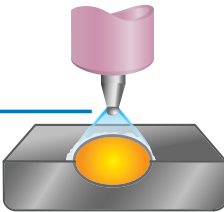
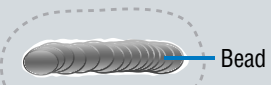
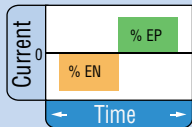
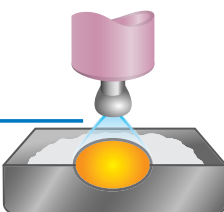
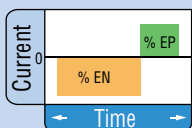
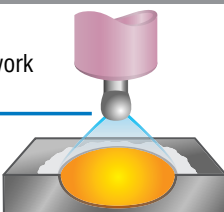
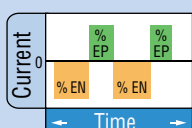
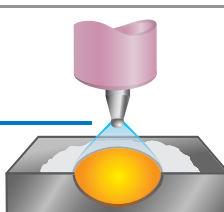
| Feature   | Setting  | Arc Effect   | Weld Effect  |
|---|--|--|--|
| <b>AC Balance Control</b><br>Controls arc cleaning action. Adjusting the % EN of the AC wave controls the width of the etching zone surrounding the weld.<br><br><i>Note: Set the AC Balance control for adequate arc cleaning (etching) action at the sides and in front of the weld puddle. AC Balance should be fine-tuned according to the amount of etching desired.</i><br><br>Balance range: Ball, 60–80%<br>Pro-Set™ setting: 68% | <b>75% EN</b><br>   | Reduces balling action and helps maintain point<br>                | <br>Bead<br>Minimum visible oxide removal (etching) |
|   | <b>50% EN</b><br> | Increases balling action of the electrode<br>                     | Bead<br>Visible oxide removal (etching)  |
| <b>AC Frequency Control</b><br>Controls the width of the arc cone. Increasing the AC Frequency provides a more focused arc and increased directional control.<br><br><i>Note: Decreasing the AC Frequency softens the arc and broadens the weld puddle for a wider weld.</i><br><br>Frequency range: 50–150 Hz<br>Pro-Set™ setting: 70 Hz   | <b>60 Hz</b><br>  | Wider profile ideal for buildup work<br>                         | Bead<br>Visible oxide removal (etching)  |
|   | <b>120 Hz</b><br> | Narrower profile for fillet welds and automated applications<br> | Bead<br>Visible oxide removal (etching)  |

# Specifications (Subject to change without notice.)



| Welding Process         | Input Power | Welding Amperage Range | Rated Output <sup>2</sup>      | Amps Input at Rated Load Output, 50/60 Hz |       |       |      |      | Max. Open-Circuit Voltage     | Dimensions  | Net Weight   |
|-------------------------|-------------|------------------------|--------------------------------|---|-------|-------|------|------|-------------------------------|---|--|
|                         |             |                        |                                | 208 V                                     | 240 V | 480 V | KVA  | KW   |                               |   |  |
| TIG <sup>1</sup> (GTAW) | 3-phase     | 5-400 A                | 400 A at 26 V, 30% duty cycle  | 40  | 36    | 17    | 14.5 | 13.8 | 70 VDC (13 VDC <sup>3</sup> ) | <b>Power Source</b><br>H: 29.4 in. (746 mm)<br>W: 15 in. (381 mm)<br>D: 24.6 in. (625 mm)<br><br><b>With Cooler and Running Gear</b><br>H: 43.9 in. (1114 mm)<br>W: 20.5 in. (521 mm)<br>D: 36.3 in. (921 mm) | <b>Power Source</b><br>131 lb. (59.4 kg)<br><br><b>With Cooler and Running Gear</b><br>211 lb. (95.7 kg) |
|                         | 1-phase     |                        |                                | 77  | 65    | 31    | 15.4 | 14.2 |                               |   |  |
|                         | 3-phase     | 5-400 A                | 300 A at 22 V, 60% duty cycle  | 25  | 23    | 11    | 9.1  | 8.8  |                               |   |  |
|                         | 1-phase     |                        |                                | 43  | 42    | 20    | 9.7  | 8.9  |                               |   |  |
|                         | 3-phase     | 5-400 A                | 250 A at 20 V, 100% duty cycle | 19  | 18    | 9     | 6.9  | 6.6  |                               |   |  |
| 1-phase                 | 36          |                        |                                | 32  | 15    | 7.4   | 6.7  |      |                               |   |  |
| Stick (SMAW)            | 3-phase     | 5-300 A                | 300 A at 32 V, 30% duty cycle  | 34  | 30    | 15    | 12.3 | 11.8 | 70 VDC (13 VDC <sup>3</sup> ) |   |  |
|                         | 1-phase     |                        |                                | 64  | 54    | 26    | 13.1 | 12.0 |                               |   |  |
|                         | 3-phase     | 5-300 A                | 250 A at 30 V, 60% duty cycle  | 27  | 24    | 12    | 9.8  | 9.4  |                               |   |  |
|                         | 1-phase     |                        |                                | 47  | 43    | 21    | 10.4 | 9.5  |                               |   |  |
|                         | 3-phase     | 5-300 A                | 200 A at 28 V, 100% duty cycle | 20  | 18    | 9     | 7.4  | 7.0  |                               |   |  |
| 1-phase                 | 35          |                        |                                | 32  | 15    | 7.7   | 7.1  |      |                               |   |  |

<sup>1</sup>Includes cooler power draw. <sup>2</sup>Refer to owner's manual for 208 V output rating and duty cycle. <sup>3</sup>Sense voltage for low OCV stick and Lift-Arc™ TIG.

Certified by Canadian Standards Association to both the Canadian and U.S. Standards.

## Performance Data

Duty Cycle Chart

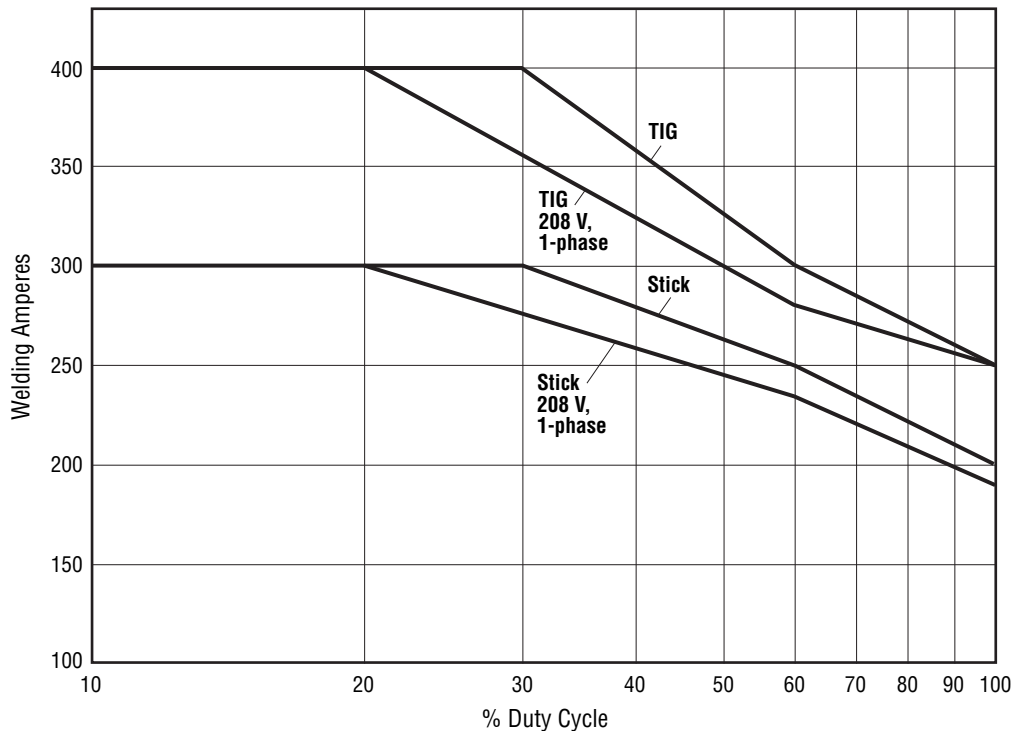

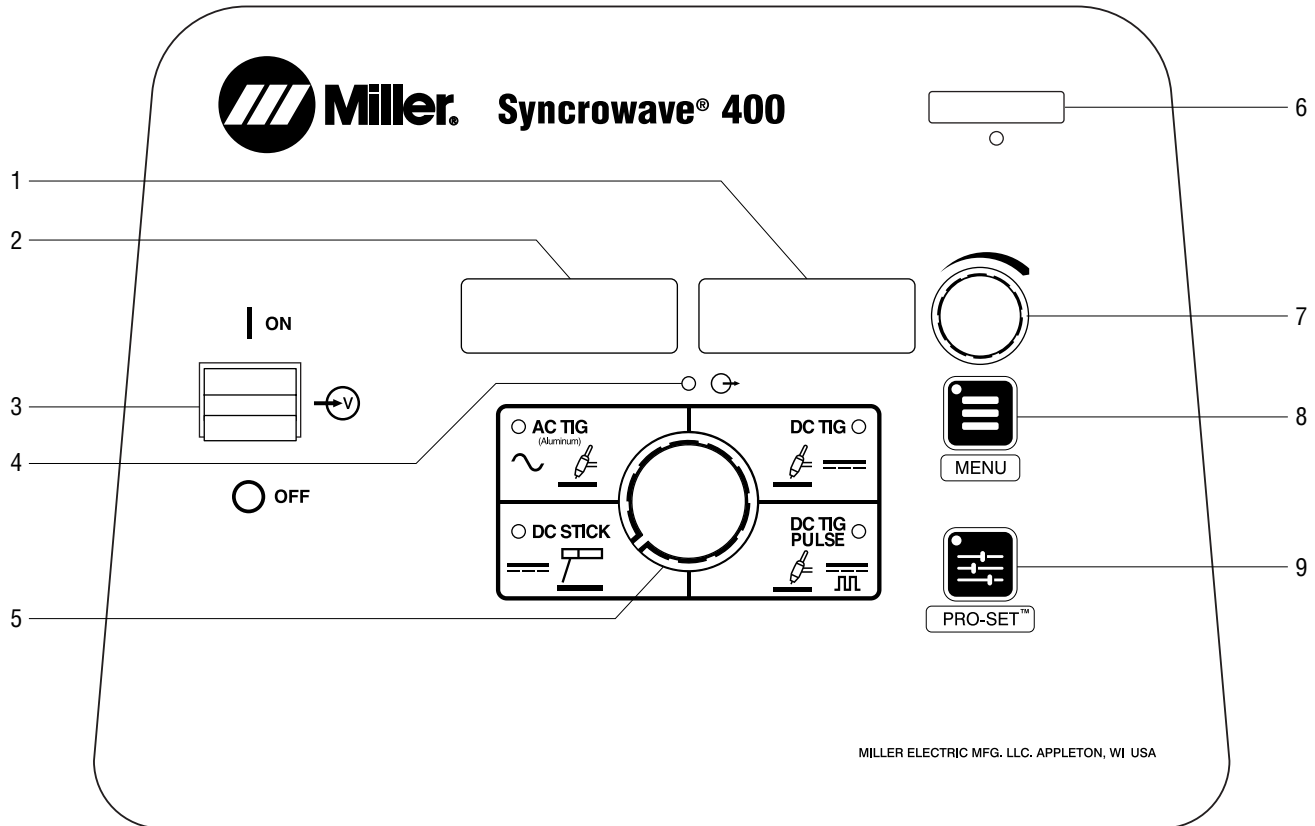

MILLER ELECTRIC MFG. LLC. APPLETON, WI USA

### 1. Ammeter

Displays actual amperage while welding and preset amperage while idle. It is also used to display parameter selection options while in the menu.

### 2. Voltmeter

Displays actual rectified average voltage when voltage is present at the weld output terminals. It is also used to display parameter descriptions while in the menu.

### 3. Main Power Switch

Use switch to turn machine on or off.

### 4. Output ON Indicator

Blue indicator illuminates when output is on.

### 5. Process Selector

**AC TIG** — Used for welding aluminum.

**DC TIG (DCEN)** — Used for welding mild and stainless steel.

**DC TIG Pulse (DCEN)** — Used for welding mild and stainless steel.

**DC Stick (DCEP)** — Used for welding steels.

### 6. Memory Card Port and Indicator

This port is used to add features to the machine and update software to the boards within the machine. Indicator is lit while card is being accessed.

### 7. Amperage Adjustment Control

Use control to change preset amperage value. If a remote control is used, preset amperage value is the maximum amperage output available. This control also functions as a parameter change control while in the menu mode.

### 8. Menu Button

Press button to scroll through available parameters for the selected process. Hold button to enter setup mode.

### 9. Pro-Set™ Button

Press button to lock in all parameters to factory settings while LED is lit. Press and hold for five seconds to reset all parameters to factory settings. Meter display counts down.

# Syncrowave® 400 Models/Packages

Machine only



## Syncrowave 400 machine Only

**907783** (208/240/480 V)

*Input power plug NOT included.*

TIGRunner®



## Syncrowave 400 TIGRunner package

**907783001** (208/240/480 V)

Completely assembled. Includes Syncrowave, Coolmate™ 3S cooler, and running gear.

*Input power plug NOT included.*

**Syncrowave 400 Complete Package with wired foot control shown.**



## Syncrowave 400 Complete packages

**951000004** (208/240/480 V) with wired foot control

**951873** (208/240/480 V) with wireless foot control

Completely assembled. Includes Syncrowave, Coolmate™ 3S cooler, running gear, RFCS-14 HD remote foot control **OR** wireless remote foot control, four gallons of TIG coolant, and a water-cooled torch kit consisting of Weldcraft™ W-375 TIG torch, AK4GL gas lens torch accessory kit, cable cover, flowmeter regulator, gas hose, torch connector, and work clamp with cable and Dinse-style connector.

*Input power plug NOT included.*

# Genuine Miller® Accessories

## Running Gear/Cylinder Rack



**Syncrowave 300/400 4-Wheel Cart 301601**  
For Syncrowave 300/400 (machine only). Cart includes storage space with latching door, handles, cylinder rack with chain, foot control holster, and cooler adapter kit. Allows for the addition of a Coolmate™ 3 externally powered cooler if desired.

## TIG Torch Kits and Connectors



**W-375 Water-Cooled Torch Kit 301268**  
Kit comes with Weldcraft™ W-375 (WP-375) 25-foot (7.6 m) TIG torch with Dinse-style connector, torch cable cover, work clamp with 15-foot (4.6 m) cable and Dinse-style connector, flowmeter regulator with gas hose and AK4GL gas lens torch accessory kit.

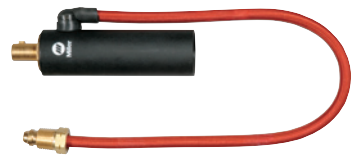

**Water-Cooled TIG Torch Connector 195377**  
50 mm Dinse-style with water return line. For use with all Weldcraft™ water-cooled torches.



**Air-Cooled TIG Torch Connector 195379**  
Used to adapt a Weldcraft™ A-200 (WP-26) torch to a Dinse-style connector.

## Remote Controls and Switches



**Wireless Remote Foot Control 301580**  
For remote current and contactor control. Receiver plugs directly into the 14-pin receptacle of Miller machine. 90-foot (27.4 m) operating range.



**Wireless Remote Hand Control 301582**  
For remote current and contactor control. Receiver plugs directly into the 14-pin receptacle of Miller machine. 300-foot (91.4 m) operating range.



**RFCS-14 HD Foot Control 301589**  
Heavy-duty foot pedal current and contactor control provides increased stability and durability from larger base and heavier cord. Includes 20-foot (6 m) cord with plug.



**RHC-14 Hand Control 242211020**  
Miniature hand control for remote current and contactor control. Dimensions: 4 x 4 x 3.25 inches (102 x 102 x 83 mm). Includes 20-foot (6 m) cord and 14-pin plug.



**RCCS-14 Remote Contactor and Current Control 043688**  
North/south rotary-motion fingertip control attaches to TIG torch using two hook-and-loop fasteners. Includes 26.5-foot (8 m) cord and 14-pin plug.



**RCC-14 Remote Contactor and Current Control 151086**  
East/west rotary-motion fingertip control attaches to TIG torch using two hook-and-loop fasteners. Includes 26.5-foot (8 m) cord and 14-pin plug.



**RMLS-14 Switch 129337**  
Momentary- and maintained-contact rocker switch for contactor control. Push forward for maintained contact and backward for momentary contact. Includes 26.5-foot (8 m) cord and 14-pin plug.



**RMS-14 On/Off Control 187208**  
Momentary-contact switch for contactor control. Rubber-covered pushbutton dome switch ideal for repetitive on-off applications. Includes 26.5-foot (8 m) cord and 14-pin plug.

**Extension Cables for 14-Pin Remote Controls**  
242208025 25 ft. (7.6 m)  
242208050 50 ft. (15.2 m)  
242208080 80 ft. (24.4 m)

## Genuine Miller® Accessories (continued)

### Coolant



#### Low-Conductivity Coolant 043810

Must be ordered in quantities of four. One-gallon recyclable plastic bottle. Miller coolants contains a base of ethylene glycol and deionized water to protect against freezing to -37° Fahrenheit (-38°C) or boiling to 227° Fahrenheit (108°C).

### TIG Welding Gloves



#### Performance TIG Gloves

**263346** Small

**263347** Medium

**263348** Large

**263349** X-Large

Completely unlined, goat grain leather with triple-padded palm.

### Educational Materials

To order, please call Miller Literature at 866-931-9732 or visit [MillerWelds.com/resources/tools](http://MillerWelds.com/resources/tools).

**Gas Tungsten Arc Welding (TIG) Publication 250833**

## Tungsten

| Tungsten          | Amp Range | 2% Ceriated (AC/DC) | 2% Lanthanated (AC/DC) |
|-------------------|-----------|---------------------|------------------------|
| 1/16 in. (1.6 mm) | 70–150 A  | WC116X7             | WL2116X7               |
| 3/32 in. (2.4 mm) | 140–250 A | WC332X7             | WL2332X7               |
| 1/8 in. (3.2 mm)  | 225–400 A | WC018X7             | WL2018X7               |
| 5/32 in. (4.0 mm) | 300–500 A | WC532X7             | WL2532X7               |

## Ordering Information

| Equipment and Options                                      | Stock No.        | Description   | Qty. | Price |
|--|------------------|---|------|-------|
| <b>Syncrowave® 400</b>                                     | <b>907783</b>    | Machine only. 208/240/480 V, 50/60 Hz   |      |       |
| <b>Syncrowave® 400 TIGRunner®</b>                          | <b>907783001</b> | 208/240/480 V, 50/60 Hz   |      |       |
| <b>Syncrowave® 400 Complete with Wired Foot Control</b>    | <b>951000004</b> | 208/240/480 V, 50/60 Hz   |      |       |
| <b>Syncrowave® 400 Complete with Wireless Foot Control</b> | <b>951873</b>    | 208/240/480 V, 50/60 Hz   |      |       |
| <b>Running Gear/Cylinder Rack</b>                          |                  |   |      |       |
| Syncrowave 300/400 4-Wheel Cart                            | <b>301601</b>    | For Syncrowave 300 and 400 with or without Coolmate 3   |      |       |
| <b>TIG Torch Kits and Connectors</b>                       |                  |   |      |       |
| W-375 Water-Cooled Torch Kit                               | <b>301268</b>    | See page 6 for contents   |      |       |
| Water-Cooled TIG Torch Connector                           | <b>195377</b>    | Connects Weldcraft™ water-cooled torches to Dinse-style connector   |      |       |
| Air-Cooled TIG Torch Connector                             | <b>195379</b>    | Connects Weldcraft™ A-200 (WP-26) torch to Dinse-style connector  |      |       |
| <b>Remote Controls</b>                                     |                  |   |      |       |
| Wireless Remote Foot Control                               | <b>301580</b>    | Foot control with wireless 90 ft. (27.4 m) operating range  |      |       |
| Wireless Remote Hand Control                               | <b>301582</b>    | Hand control with wireless 300 ft. (91.4 m) operating range   |      |       |
| RFCS-14 HD   | <b>301589</b>    | Heavy-duty foot control   |      |       |
| RHC-14   | <b>242211020</b> | Hand control  |      |       |
| RCCS-14  | <b>043688</b>    | North/south fingertip control   |      |       |
| RCC-14   | <b>151086</b>    | East/west fingertip control   |      |       |
| RMLS-14  | <b>129337</b>    | Momentary/maintained rocker switch  |      |       |
| RMS-14   | <b>187208</b>    | Momentary rubber dome switch  |      |       |
| Extension Cables   |                  | See page 6  |      |       |
| <b>Accessories</b>   |                  |   |      |       |
| TIG Coolant<br>(must be ordered in quantities of four)     | <b>043810</b>    | 1-gallon plastic bottle. Protects against freezing to -37° Fahrenheit (-38°C) or boiling to 227° Fahrenheit (108°C) |      |       |
| TIG Welding Gloves   |                  | See page 7  |      |       |
| Gas Tungsten Arc Welding (TIG) Publication<br>Tungsten     | <b>250833</b>    | See page 7  |      |       |
| <b>Cable Connectors and Adapters</b>                       |                  |   |      |       |
| Dinse-Style Connector 50 mm (1 male)                       | <b>042418</b>    | Used to connect weld lead to Dinse terminal machine   |      |       |
| Dinse-Style Connector 50 mm<br>(1 male, 1 female)          | <b>042419</b>    | Used to extend weld cables  |      |       |
| Dinse/Tweco® Adapter                                       | <b>042465</b>    | Male Dinse-style to female Tweco  |      |       |
| Dinse/Cam-Lok Adapter                                      | <b>042466</b>    | Male Dinse-style to female Cam-Lok  |      |       |
| <b>Educational Materials</b>                               |                  |   |      |       |
|  |                  | See page 7  |      |       |

Date:

Total Quoted Price:

Distributed by:

